

CUSTOMER NO:	REMARK
CPV0014	

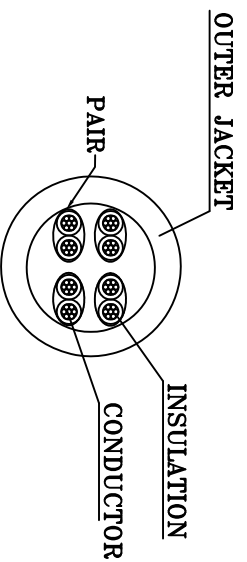

WIRE SECTION

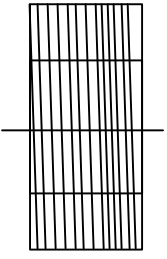
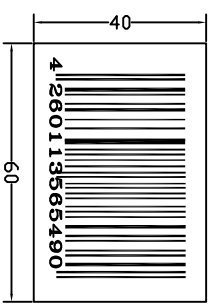
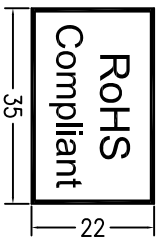
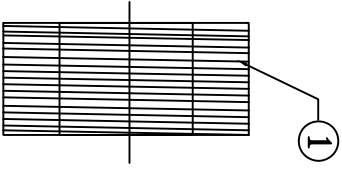
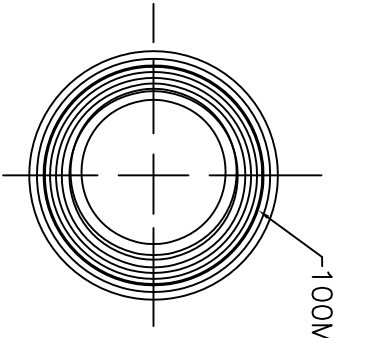
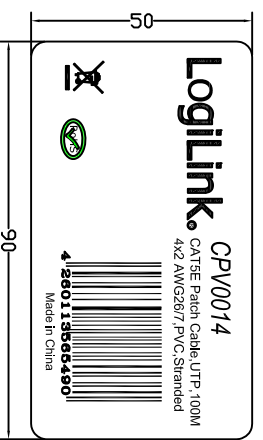

- NOTES:**
- 1) CABLE LENGTH:100M
 - 2) EASY PULL WHITE BOX
 - 3) IPC 50*90mm sticker on both sides of white box
 - 4) IPC 40*60mm EAN sticker on shipping mark of outer carton
 - 5) ROHS abel on the side of EAN label
 - 3) Cable is with ROHS COMPLIANT

CABLE:

1) CAT.5E UTP 26#4P(7*0.16)CCA, STRANDED TYPE OD:5.5MM
 LIGHT GRAY(3014) 100M/ROLL. (ROHS)
 CABLE PRINTER:UTP CAT.5e NETWORKING PATCH CABLE AWG 26/7*4P

A	FIRST EDITION		
REV	DESCRIPTION	DR	DATE
2DIRECCT GMBH			
TITLE	P/N	CPV0014	
UTP CABLE (ROHS)	DR	gmx 30/09/07	
Drawing no.:	APPD:	CONF:	UNIT:MM
CHKD:			
			SIZE:A4